

IUCD Instrument Pack Plastic



- Single use pack comprising of
- 1 x Sponge Forceps
- 1 x Uterine Scissors
- 1 x Tenaculum Forceps
- 1 x Uterine Sound



9534 IUCD Instrument Set Plastic

£3.95

IUCD Instrument Pack



- Single use pack comprising of
- 1 x Mayo Scissors Curved 19cm
- 1 x Rampleys Sponge Holder 24cm
- 1 x Teales Vulsellum Curved 23cm
- 1 x Procedure Sheet/Sterile Field 45 x 50 cm



7517 IUCD Instrument Pack

£7.50

IUCD Instrument Pack with Galabin Sound

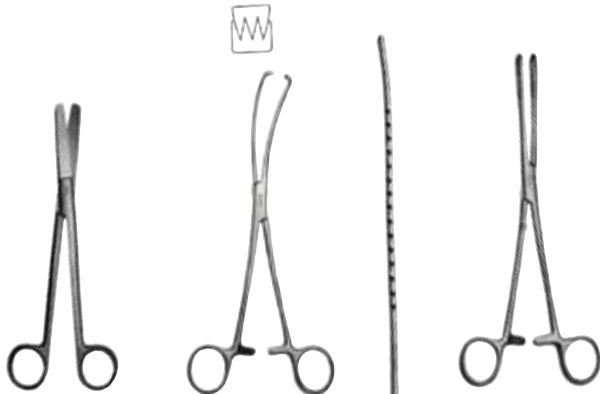

- Single use pack comprising of
- 1 x Sims Uterine Scissors
- 1 x Rampley Sponge Forceps
- 1 x Teales Vulsellum Forceps Curved
- 1 x Uterine Galabin Sound



9535 IUCD Instrument Pack with Galabin Sound

£8.55

IUCD Comprehensive Packs



- Choice of packs; with or without Uterine Sound

- Single use pack comprising of
- 1 x Tray
- 1 x 120ml Gallipot
- 1 x 700ml Kidney Dish
- 1 x Mayo Scissor Curved 19cm
- 1 x Rampley Sponge Holder 24cm
- 5 x Large Cotton Wool Balls
- 1 x Teales Vulsellum Curved 23cm
- 1 x Cosco Medium Speculum
- 1 x Drape 75 x 95cm
- 1 x Dressing Towel 38 x 40 cm
- 1 x Sterile Field
- 1 x Galabin Uterine Sound
- available with code 6546 only



6546 IUCD Pack with Sound

£13.95

6547 IUCD Pack without Sound

£12.95

IUCD Fitting Pack



- Single use pack comprising of
- 1 x Vaginal Speculum
- 1 x Uterine Sound
- 1 x Rampley Sponge Forceps
- 1 x Uterine Scissor Curved
- 1 x Teales Vulsellum Forceps
- 1 x Lubricating Gel Sachet 5g



9536 IUCD Fitting Pack

£10.20

IUCD Premium Fitting Pack



- Single use pack comprising of
- 1 x Tray
- 1 x Crepe Paper
- 1 x Towel Dressing
- 1 x Paper Tissue
- 1 x 120ml Gallipot
- 1 x Kidney Tray
- 5 x Large Cotton Wool Balls
- 1 x Rampley Forceps
- 1 x Uterine Sound
- 1 x Teales Vulsellum Forceps
- 1 x Vaginal Speculum



9537 IUCD Premium Fitting Pack

£12.25

HRT Pack



- Single use pack comprising of
- 1 x Tray
- 1 x Plastic Blue
- 1 x Plastic Blue Tweezers
- 1 x Scalpel No 11
- 2 x Vinyl Gloves, Non Sterile, Powder Free, Medium
- 1 x Waterproof Drape 50 x 50 cm with 6 x 6 cm hole
- 5 x Woven Swabs, 10 x 10 cm, 8 ply
- 2 x Dressing Towel 43 x 38 cm
- 1 x Trochar and Cannula
- 1 x Plaster
- 1 x Tisept
- 1 x Injection Wipes
- 1 x 5ml Syringe
- 1 x 23G Hypodermic Needle
- 1 x 21G Hypodermic Needle
- 5 x Small Cotton Wool Balls

9538 HRT Pack

£17.95

Basic Vaginal Examination Pack

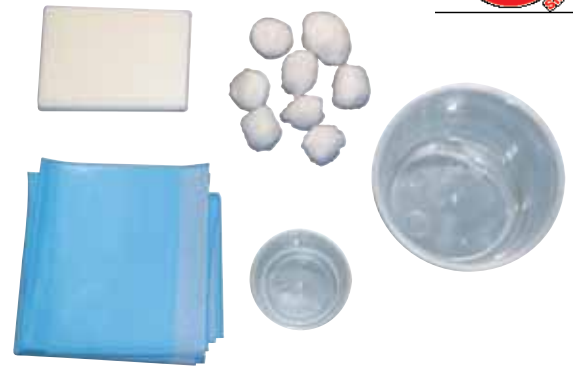

- Single use pack comprising of
- 1 x 60ml Gallipot
- 1 x 500ml Bowl
- 8 x Large Cotton Wool Balls
- 1 x Dressing Towel 43 x 38 cm
- 1 x Sterile Field

6515 Basic Vaginal Examination Pack

£0.65

Obs & Gynae Pack



- Single use pack comprising of
- 1 x Tray
- 2 x 120ml Gallipot
- 2 x 10 x 10 cm Non Woven Swab 4 ply
- 1 x Large Maternity Pad
- 5 x Medium Cotton Wool Balls
- 2 x Dressing Towel 38 x 40 cm
- 1 x Sterile Field

6516 Obs & Gynae Pack

£0.95

Vaginal Examination Pack



- Single use pack comprising of
- 1 x 60ml Gallipot
- 1 x 120ml Gallipot
- 5 x X-Ray Det Swab
- 1 x Large Maternity Pad
- 1 x Fenestrated Drape 60 x 60 cm
- 1 x Dressing Towel 38 x 40 cm
- 1 x Sterile Field
- 1 x Yellow Disposal Bag

6517 Vaginal Examination Pack

£1.25

Implant Insertion Pack



- Single use pack comprising of
- 1 x Blister With 2 Integral Gallipot
- 1 x Fold-out Sterile Field 60 x 60 cm
- 1 x Adhesive Fenestrated Sheet with Hole
- 1 x Alcohol Pad 70
- 1 x Syringe 2ml
- 1 x Hypodermic Needle 16 x 0.5
- 1 x Hypodermic Needle 25 x 0.8
- 1 x Stretch Bandage
- 2 x Non Woven Swabs 10 x 10 cm 4 ply
- 1 x Plaster 5 x 7.2 cm
- 1 x Yellow Bag & Tie

9539 Implant Insertion Pack

£2.25

Implant Removal Pack



- Single use pack comprising of
- 1 x Blister with 2 Integral Gallipot
- 1 x Fold-out Sterile Field 60 x 60 cm
- 1 x Adhesive Fenestrated Drape with Hole
- 1 x Halstead Mosquito Forceps Curved
- 1 x Scalpel No 15
- 2 x Non Woven Swabs 10 x 10 cm 4 ply
- 3 x Reinforced Skin Closures
- 1 x Stretched Bandage
- 1 x Syringe 2ml
- 1 x Hypodermic Needle 16 x 0.5
- 1 x Yellow Bag & Tie

9540 Implant Removal Pack

£4.45

Bronze Suture Pack, Standard Contents



- Single use pack comprising of
 - 1 x Small Tray
 - 1 x 60ml Gallipot
 - 2 x Hand Towels
 - 5 x 7.5 x 7.5 cm Non Woven Swab, 4 ply
 - 1 x Iris Scissor
 - 1 x Kilner Needle Holder
 - 1 x Gilles Dissecting Forcep Plain
 - 1 x Gilles Dissecting Forcep Toothed
 - 1 x Sterile Field

6545 Bronze Standard Suture Pack

£3.25

Bronze Suture Pack, Fine Contents



- Single use pack comprising of
 - 1 x Small Tray
 - 1 x 60ml Gallipot
 - 2 x Hand Towels
 - 5 x 7.5 x 7.5 cm Non Woven Swab, 4 ply
 - 1 x Iris Scissor
 - 1 x Kilner Needle Holder
 - 1 x Dressing Forcep 10cm
 - 1 x Dressing Forcep Toothed 10cm
 - 1 x Sterile Field

6544 Bronze Fine Suture Pack

£3.32

Silver Suture Pack, Standard Contents



- Single use pack comprising of
 - 1 x Blister with 2 Integral Gallipot
 - 1 x Fold-out Sterile Field 60 x 60 cm
 - 1 x Treves Dissecting Forceps
 - 1 x T.O.E Dissecting Forceps
 - 1 x Iris Scissor Straight
 - 1 x Kilner Needle Holder
 - 2 x Dressing Towel 43 x 38 cm
 - 5 x Non Woven Swabs 10 x 10 cm 4 ply
 - 1 x Yellow Bag & 1 Tie

9541 Silver Standard Suture Pack

£3.60

Silver Suture Pack, Fine Contents



- Single use pack comprising of
 - 1 x Blister with 2 Integral Gallipot
 - 1 x Fold-out Sterile Field 60 x 60 cm
 - 1 x Iris Non Toothed Dissecting Forceps
 - 1 x Iris Toothed Dissecting Forceps
 - 1 x Kilner Needle Holder
 - 1 x Iris Scissors Straight
 - 2 x Dressing Towel 43 x 38 cm
 - 5 x Non Woven Swabs 10 x 10 cm 4 ply
 - 1 x Yellow Bag & 1 Tie

9542 Silver Fine Suture Pack

£3.65

Gold Suture Pack, Standard Contents



- Single use pack comprising of
 - 1 x Blister with 2 Integral Gallipot
 - 1 x Fold-out Sterile Field 60 x 60 cm
 - 1 x Sharp/Sharp Dressing Scissors
 - 1 x Halstead Mosquito Forceps Curved
 - 1 x Iris Non Toothed Dissecting Forceps
 - 1 x Iris Toothed Dissecting Forceps
 - 1 x Kilner Needle Holder
 - 1 x Dressing Towel 43 x 38 cm
 - 1 x Paper Blue Tissue, 60 x 60 cm
 - 5 x Non Woven Swabs 12 x 12 cm 4 ply
 - 1 x Yellow Bag & 1 Tie

9543 Gold Standard Suture Pack

£3.95

Gold Suture Pack, Fine Contents



- Single use pack comprising of
 - 1 x Blister with 2 Integral Gallipot
 - 1 x Fold-out Sterile Field 60 x 60 cm
 - 1 x Iris Scissor Straight
 - 2 x Halstead Mosquito Forceps Straight
 - 1 x Iris Non Toothed Dissecting Forceps
 - 1 x Iris Toothed Dissecting Forceps
 - 1 x Kilner Needle Holder
 - 1 x Dressing Towel 43 x 38 cm
 - 1 x Paper Blue Tissue, 60 x 60 cm
 - 5 x Non Woven Swabs 12 x 12 cm 4 ply
 - 1 x Yellow Bag & 1 Tie

9544 Gold Fine Suture Pack

£4.40

Incision Pack



- Single use pack comprising of
- 1 x Tray, Half Shallow
- 1 x No.3 Scalpel with No.15 Blade
- 1 x Plain Dissecting Forcep
- 1 x Sinus Forcep
- 1 x Probe
- 1 x Scissors Sharp/Sharp 13cm
- 1 x Sterile Field



6548 Incision Pack

£4.25

Excision Pack



- Single use pack comprising of
- 1 x Tray, Half Shallow
- 1 x No.3 Scalpel with No.15 Blade
- 1 x Kilner Needle Holder
- 1 x Mosquito Artery Forcep
- 1 x Toothed Dissecting Forcep
- 1 x Scissors Sharp/Sharp 13cm
- 1 x Metzebaum/McIndoe Scissor 18cm
- 1 x Sterile Field



6549 Excision Pack

£7.75

Small Suture Removal Pack



- Single use pack comprising of
- 3 x 5 x 5 cm Swabs
- 1 x Dressing Towel 25 x 25 cm
- 1 x Forceps
- 1 x Stitch Cutter
- 1 x Yellow Disposal Bag



6514 Small Suture Removal Pack

£0.33

Medium Suture Removal Pack



- Single use pack comprising of
- 1 x Tray with 2 Integral Gallipots
- 1 x Fold-out Sterile Field 38 x 43 cm
- 1 x Blue Minigrip Forceps
- 1 x Stitch Cutter
- 3 x Non Woven Swabs 10 x 10 cm
- 1 x Yellow Bag & 1 Tie



9545 Medium Suture Removal Pack

£0.60

Small Dressing Pack



- Single use pack comprising of
- 1 x Tray
- 1 x 60ml Gallipot
- 10 x 7.5 x 7.5 cm Swab, 4 ply
- 4 x Forceps
- 1 x Dressing Towel 43 x 43 cm
- 1 x Sterile Field

6513 Small Dressing Pack

£0.83

Medium Dressing Pack



- Single use pack comprising of
- 1 x 3-Part Tray
- 3 x 7.5 x 7.5 cm Non Woven Swab, 4 ply
- 3 x Medium Cotton Wool Balls
- 2 x Forceps
- 1 x 60cm Sterile Field
- 1 x Yellow Disposal Bag

6512 Medium Dressing Pack

£1.04

National Wound Care Pack No.1



- Single use pack comprising of
 - 1 x Tray with 2 Integral Gallipots
 - 1 x Fold-out Sterile Field 38 x 43 cm
 - 1 x Blue Minigrip Forceps
 - 1 x Stitch Cutter
 - 3 x Non Woven Swabs 10 x 10 cm
 - 1 x Yellow Bag & 1 Tie



9546 National Wound Care Pack No.1

£0.39

National Wound Care Pack No.2



- Single use pack comprising of
 - 1 x Tray
 - 1 x Sterile Filed Size 50 x 50 cm
 - 1 x Dressing Towel 43 x 38 cm
 - 1 x Pair nitrile gloves, Medium Size
 - 1 x Non Woven Swabs, Size 7.5 x 7.5 cm
 - 1 x 60ml Gallipot
 - 1 x Yellow Bag



9547 National Wound Care Pack No.2

£0.41

Minor Surgical Pack



- Single use pack comprising of
 - 1 X Blister with 2 Integral Gallipots
 - 1 x Fold-out Sterile Field 60 x 60 cm
 - 1 x Absorbent Fenestrated Adhesive Drape with Hole
 - 10 x Non Woven Swabs 12 x 12 cm 4 ply
 - 1 x Dressing Towel 43 x 38 cm
 - 1 x Yellow Bag & 1 Tie



9548 Minor Surgical Pack

£2.80

Minor Surgery Pack Standard



- Single use pack comprising of
 - 1 x Tray
 - 1 x Crepe Paper 60 x 60 cm
 - 1 x Crepe Paper 90 x 90 cm
 - 1 x Gallipot 60ml
 - 1 x Adson Non Toothed Dissecting Forceps
 - 1 x Adson Toothed Dissecting Forceps
 - 1 x Derf Needle Holder
 - 1 x Halstead Mosquito Forceps Straight
 - 1 x Iris Scissors Curved
 - 1 x Bard Parker Handle
 - 1 x Blade No 15
 - 1 x Scissors 13.5cm Sharp/Blunt Yellow Handles
 - 1 x Non Woven Swabs 10 x 10 cm 4 ply
 - 1 x Dressing Towel 43 x 38 cm
 - 1 x Yellow Bag & Tie

9550 Minor Surgery Pack Standard

£5.25

Minor Surgery Pack Extra



- Single use pack comprising of
 - 1 x Tray
 - 1 x No.3 Scalpel with No.11 Blade
 - 5 x 10 x10 cm Non Woven Swab, 4 ply
 - 1 x 60ml Gallipot
 - 1 x Kilner Needle Holder
 - 1 x Adson Toothed Dissecting Forcep 14cm
 - 2 x Mosquito Artery Forcep Curved 13cm
 - 1 x Iris Scissor
 - 1 x Metzenbaum Scissor Curved 13cm
 - 2 x Hand Towels
 - 1 x Drape with Adhesive Fenestration
 - 1 x Sterile Field

6550 Minor Surgery Pack Extra

£11.35

Minor Surgery Pack Super



- Single use pack comprising of
 - 1 x Tray
 - 1 x Drape Laminated Green 75 x 110 cm
 - 1 x Blade Carbon Steel No 15
 - 2 x Gallipot 60ml
 - 1 x Gallipot 250ml
 - 1 x Lawrence Needle Holder 15cm
 - 1 x Gillis Skin Hook Retractor Fine 16.5cm
 - 1 x Adson Non-Toothed Dissecting Forceps
 - 1 x Adson Toothed Dissecting Forceps
 - 1 x Halstead Mosquito Forceps Straight
 - 1 x Halstead Mosquito Forceps Curved
 - 1 x Iris Scissor Straight
 - 1 x Strabismus Scissors Curved Blunt 11cm
 - 1 x Dressing Scissors Blunt/Blunt
 - 1 x Scalpel Blade No 3
 - 2 x Utility Drape S/a 75 x 75cm
 - 2 x Sterile Towel 48 x 40 cm
 - 3 x Non Woven Balls Medium
 - 5 x Non Woven Swabs 12 x 12 12 ply
 - 1 x Yellow Bag & 1 Tie

9551 Minor Surgery Pack Super

£15.37

Eye Dressing Pack



- Single use pack comprising of
 - 1 x Tray with 2 Integral Gallipots
 - 1 x Fold-out Sterile Field 38 x 43 cm
 - 5 x Non Woven Swabs 5 x 5 cm 4 ply
 - 3 x Non Woven Balls
 - 1 x Dressing Towel 43 x 38 cm
 - 1 x Eye Pad
 - 1 x Yellow Bag & 1 Tie



9549 Eye Dressing Pack

£0.50

Drug Tariff Dressing Pack



- Available as Spec 35 with non woven swabs or as Spec 10 with woven swabs - Please specify when ordering
- Single use pack comprising of
 - 1 x Fold-out Sterile Field
 - 1 x Absorbent Paper Towel 38 x 43 cm
 - 4 x Small Cotton Wool Balls
 - 4 x Swabs 10 x 10 cm 4 ply
 - 1 x Dressing Pad 10 x 20 cm



9554 Drug Tariff Dressing Pack

£0.62

Vasectomy Pack



- Single use pack comprising of
 - 1 x Blue Plastic Tray
 - 1 x Sterile Field
 - 1 x Crepe 90 x 90 cm
 - 1 x Waterproof Drape 60 x 60 cm
 - 1 x Kidney Pp Bowl
 - 5 x Non Woven Gauze Balls Large
 - 1 x 120ml Gallipot
 - 1 x Towel Dressing
 - 1 x Yellow Bag & Tie
 - 1 x Mosquito Curved Forceps
 - 1 x Rampley Sponge Forceps 24cm
 - 1 x Vasectomy Forceps Mosquito Plain Sharp
 - 1 x Iris Dissecting Forceps Toothed Forceps 10cm
 - 1 x Kilner Needle Holder 13.5cm
 - 1 x Iris Scissor Straight 11cm



9552 Vasectomy Pack

£13.35

National Catheterisation Pack



- Single use pack comprising of
 - 1 x Pulp Kidney Tray
 - 1 x Sterile Field 60 x 60 cm
 - 1 x 60ml Gallipot
 - 1 x Large Non Woven Balls
 - 3 x Non Woven Swabs, Size 10 x 10 cm
 - 1 x Blue Paper/ Field Size 60 x 55 cm



9553 National Catheterisation Pack

£0.71

Maternity Pack



- Single use pack comprising of
 - 2 x Maternity Pad Large
 - 1 x Absorbency Square
 - 1 x Maternity Bag
 - 1 x Gloves - Non Powdered
 - 1 x Baby Towelling
 - 1 x Maternity Pack Label
 - 1 x Umbilical Cord Scissors
 - 1 x Umbilical Cord Clamp
- Provides all the essential items needed to handle an emergency birth

7538 Maternity Pack

£24.00

Basic Podiatry Pack



- Latex free
- Single use pack comprising of
 - 1 x Tray
 - 1 x Crepe Paper 60 x 60 cm
 - 1 x Nail Cutter 14cm
 - 1 x Toe Nail Scissor
 - 1 x Medium Nail File 13.5cm
 - 1 x Foot Dresser 8"
 - 1 x Scalpel No.11 Blade
 - 1 x Dressing Towel 43 x 38 cm



0877 Basic Podiatry Pack

£5.35

IUCD Removal Hook

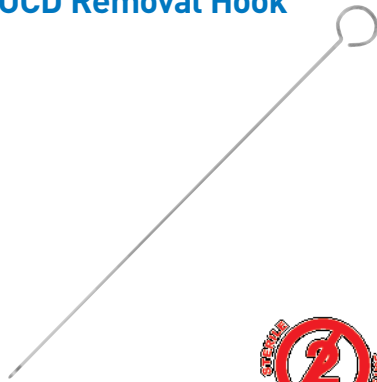

• Stainless Steel



6533 IUCD Removal Hook £1.60

ProSpec Thread Retriever



• Plastic
• 12 Micro Teeth - hook the thread effectively
• Dimensions - overall length 29.8cm - handle 20.4cm to toothed section 9.4cm



3847 Thread Retriever, pk/5 £10.25

Braun Tenaculum Forceps 24.5cm



• Stainless Steel



9561 Tenaculum £3.05

Ramplays Sponge Holder



• Stainless Steel



6536 Sponge Holder 18cm £2.64
6537 Sponge Holder 24cm £3.60

Sponge Holder 24cm



• Plastic



9512 Sponge Holder 24cm £0.65

Allis Tissue Forceps



• Stainless Steel



9563 Allis Tissue Forceps 15cm £2.38
9564 Allis Tissue Forceps 23cm £3.08

Teales Vulsellum Forceps



• Stainless Steel



6534 Straight 23cm £3.40
6532 Curved 18cm £3.00
6535 Curved 23cm £3.40

Teales Vulsellum Tissue Forceps 25cm



• Plastic



9565 Teales Vulsellum £0.88

Tenaculum Forceps 26cm



• Plastic



9566 Tenaculum Forceps, 26cm £0.88

Cervix Dilators Double Ended 22cm



• Stainless Steel
• Available in 1/2, 3/4, 5/6, please specify size when ordering



9589 Cervix Dilators £1.28

ProSpec Disposable Hegar Dilators

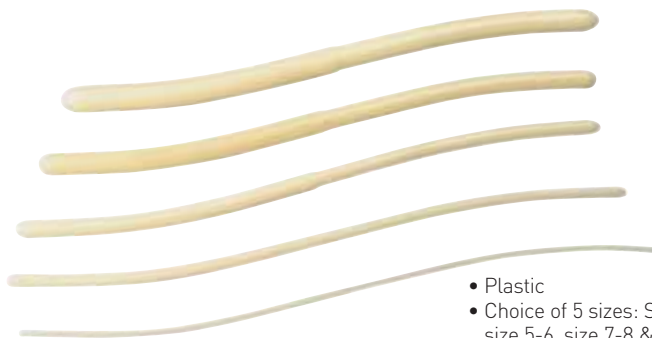

• Plastic
• Choice of 5 sizes: Size 1-2, size 3-4, size 5-6, size 7-8 & size 9-10, please specify size when ordering



6761 Hegar Dilators, pk/5 £5.50

Sound and Dilator Double Ended

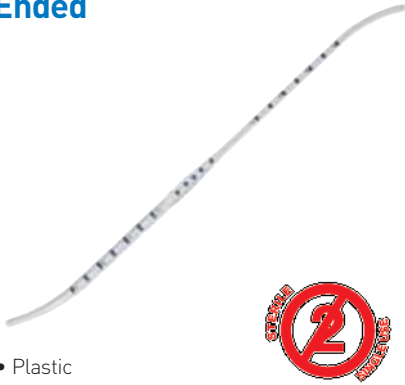

• Plastic

9567 Sound and Dilator £1.55



Sound 25cm



• Plastic

9568 Sound 25cm £0.71



Gillies Dissecting Forceps Toothed 15cm



• Stainless Steel

9569 Dissecting Forceps £1.95



Iris Forceps 10cm



• Stainless Steel

6529 Iris Forceps Toothed £0.91
6530 Iris Forceps Non-Toothed £0.91



Treves Forceps Toothed 12.5cm



• Stainless Steel

9570 Treves Forceps £0.88



Dissecting Forceps/Tweezers 13cm



• Plastic

9434 Tweezers £0.11



Martins Splinter Forceps 12cm



• Stainless Steel

9572 Martins Splinter Forceps £0.89



T.O.E Dissecting Forceps 12.5cm



• Stainless Steel

6528 T.O.E Dissecting Forceps £0.80



Adson Forceps



• Stainless Steel
• Toothed 12cm
• Non-toothed 12.5cm

9593 Adson Forceps £0.82



Hunter Splinter Forceps 10cm



• Stainless Steel

6540 Hunter Splinter Forceps £1.25



Mayo Needle Holder Straight 20cm



• Stainless Steel

9573 Mayo Needle Holder £2.25



Kilner Needle Holder 13.5cm



• Stainless Steel

6527 Kilner Needle Holder £1.18



Strabismus Scissors Fine 11cm



- Stainless Steel
- Available Straight or Curved



9596 Strabismus Scissors £0.83

Iris Scissors 11cm



- Stainless Steel



6522 Iris Scissors Straight 11cm £0.93
6523 Iris Scissors Curved 11cm £0.93

Iris Fine Straight Scissors 11cm



- Stainless Steel



9574 Fine Iris Scissors £0.93

Mayo Scissors Straight 14cm



- Stainless Steel



6519 Mayo Scissors 14cm £1.35

Mayo Scissors 17cm



- Stainless Steel
- Available Straight or Curved



9599 Mayo Scissors 17cm £1.73

Mayo Scissors 19cm



- Stainless Steel



6520 Mayo Scissors Straight 19cm £1.85
6521 Mayo Scissors Curved 19cm £2.10

Dressing Scissors Straight



- Stainless Steel



6526 Scissors Sharp/Sharp £0.83
0883 Scissors Sharp/Blunt £0.83

Long Scissors 22cm



- Plastic



9575 Long Scissors £0.94

Uterine Sims Scissors Curved 20cm



- Stainless Steel



9576 Uterine Sims Scissors £2.95

Pocket Scissors, Green



- Stainless Steel



6524 Scissors Sharp/Sharp £0.45
6525 Scissors Sharp/Blunt £0.45

Umbilical Scissors 10cm



- Stainless Steel



9577 Umbilical Scissors £1.40

Stitch Scissors 12cm



- Plastic



9578 Stitch Scissors £0.47

Silver Probe with Eye 13cm



• Stainless Steel



9579 Probe with Eye £0.55

Lister Sinus Forceps



• Stainless Steel



9580 Lister Sinus Forceps 13cm £1.28
9581 Lister Sinus Forceps 15cm £1.48

Halstead Mosquito Forceps 13cm



• Stainless Steel



0880 Mosquito Forceps Straight £0.90
0881 Mosquito Forceps Curved £0.90

3M Skin Stapler



• Pre-loaded with 5 staples
• Suitable for simple, recent, open, unbruised wounds



7392 Skin Stapler £8.10

3M Skin Staple Remover



• Suitable for use with most brands of skin staples



7393 Skin Staple Remover £3.60

Skin Staple Remover with Plastic Handle 11cm



9582 Skin Staple Remover £2.45

Spencer Wells Artery Forceps 18cm



6531 Wells Artery Forceps £2.10

Gillies Skin Hook 18cm



9583 Gillies Skin Hook £1.69

Kilner Catspaw D/E 16.5cm



9584 Kilner Catspaw D/E £2.08

Volkman Spoon D/E 22cm



• Stainless Steel
• Available in Small, Medium and Large - please specify when ordering



9600 Volkman Spoon D/E £2.60

St Barts Wax Hooks 8cm



• Stainless Steel

9587 St Barts Wax Hooks £2.25

Jobson Horne Probe



• Stainless Steel



9588 Jobson Horne Probe 13cm £0.98
6539 Jobson Horne Probe 18cm £1.24

Hartmann Crocodile Forceps 13cm



- Stainless Steel



6538 Crocodile Forceps £4.75

Tilley Nasal Forceps

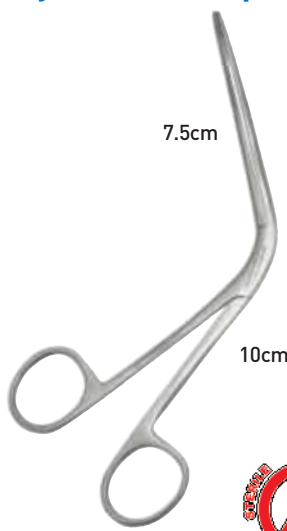

- Stainless Steel



9586 Tilley Nasal Forceps £2.05

Tilley Aural Forceps

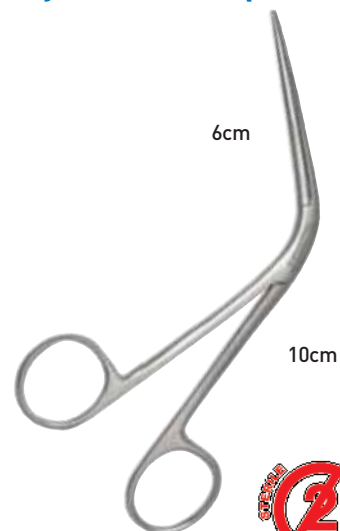

- Stainless Steel



9585 Tilley Aural Forceps £2.40

Vasectomy Forceps 15cm



- Stainless Steel
- Available Blunt or Sharp



9601 Vasectomy Forceps £1.85

No Scalpel Vasectomy (NSV) Ringed Forceps 4mm



- Stainless Steel
- Sterile single use, individually wrapped
- Forcep holds firmly without pinching or crushing the delicate tissues around the vas



9836 NSV Forcep 4mm, pk/20 £110.00

No Scalpel Vasectomy (NSV) Sharp Haemostat



- Stainless Steel
- Sterile single use, individually wrapped
- Sharp Haemostat for tissue dissection



9837 NSV Haemostat, pk/20 £110.00

Nail Cutter Curved



- Cutter blade
- Double spring
- Handel lock
- 14cm



0891 Nail Cutter £2.75

Drapes



- Sterile
- Water repellent



6518 Procedure Drape
90 x 90cm, pk/90 £32.00

Klinidrape Adhesive Drapes



- Sterile
- Water repellent
- Adhesive



9773 Klinidrape 75 x 75cm,
pk/28 £47.95

Heine Sigmoidoscope-Proctoscope Kit RTE



- Complete system for proctological examination and treatment
- Disposable tubes negate the need for cleaning and sterilisation and greatly reduce the risk of cross-infection
- 6v Halogen illumination ensures a clear view
- Powered from Heine E7 mains transformer and lamp handle
- Fibre optic instrument head with 1.5x magnification lens and air-tight viewing window
- Supplied with box of 25 Heine disposable sigmoidoscopes, 1 box of 25 Heine disposable proctoscopes, 1 box of 25 disposable anoscopes, E7 power source, F.O. instrument head, Sponge holding forceps and insufflation bulb

9898 Sigmoidoscope-Proctoscope Kit £649.00

Heine Disposable Anoscopes, Proctoscopes and Sigmoidoscopes



- Disposable single-use, no cleaning or sterilisation
- Greatly reduces risk of cross-infection
- Moulded in patient friendly thermoplastic
- Excellent light transmission through tube wall
- Removable obturator for easy insertion
- Graduated in cm for indication of insertion length



9690	Anoscopes, pk/25	£35.50
9691	Proctoscopes, pk/25	£50.50
9692	Sigmoidoscopes, pk/25	£62.00

ProSpec Disposable Proctoscope



- High quality single use proctoscope, supplied individually packed
- Made from non toxic plastic with non-heavy metals
- Suitable for use with BiHex Ligator set
- Optional light source and single use lighting stem available
- Choice of 3 sizes – Small 50 x 22.5mm, Medium 53 x 26mm, Large 55 x 30mm, specify size when ordering

6768	Disposable Proctoscope, pk/20 – specify size	£20.00
9693	Light Source	£168.30
9688	Single Use Lighting Stem	£1.52

BiHex Haemorrhoid Single-use Ligator Set



- Ligator gun made from non-toxic plastic
- Moulded handle for easy application of bands
- Can be used with suction and grasping forceps
- Haemorrhoids easily visualised
- Eliminates need for cleaning/sterilisation, reducing risk of cross infection
- 7" working length
- Includes 4 bands in each pack
- Supplied sterile individually packed, in packs of 15

9897 Haemorrhoid Ligator Set, pk/15 £170.00

Haemoband Multi-Ligator

- Disposable device that facilitates the easy Rubber Band Ligation of Haemorrhoids
- Offers a very attractive alternative to current devices by providing an easy to use, ergonomically designed product, pre-loaded with four rubber bands
- The unit has been designed to optimise, simplify and substantially reduce cost of the ligation process
- Simple to use, just position the multi-ligator as required and gently squeeze the trigger to induce suction. Continue to pull the trigger to its final position to apply the band, then release the trigger to reduce suction and free the haemorrhoid. Automatically reloaded with the next band ready for immediate use
- Slim 20mm insertion probe
- Optional tubing to assist with the suction process



9832	Haemoband Multi-Ligator, pk/10	£165.50
9833	Suction Tubing 1.5m, pk/10	£10.00



Dressing Scissors



• Blunt/blunt

6445 Straight 13cm 5" £2.10
3235 Straight 15cm 6" £3.95

Stitch Scissors



• Sharp/sharp

6446 Straight 13cm 5" £2.10
1188 Straight 15cm 6" £3.95

Vigo Scissors



• Blunt/sharp

1187 Straight 13cm 5" £3.95
1186 Straight 15cm 6" £3.95

Spencer Wells Forceps



6459 Straight 13cm 5" £3.65
1172 Straight 15cm 6" £4.25
6460 Straight 20cm 8" £5.75
1176 COF 13cm 5" £4.25

Dunhills Forceps



6457 COF 13cm 5" £5.05

Halstead Mosquito Forceps



1171 Straight 13cm 5" £3.50
6458 COF 13cm 5" £4.25

Hartman Extra Fine Forceps



1173 Straight 9cm 3.5" £3.25
1177 COF 9cm 3.5" £3.25

Lister Bandage Scissors



1185 Straight 18cm 7" £4.15

TufCut Scissors



1189 TufCut 18cm 7" £2.95

Sims Uterine Scissors



6451 Sims 20cm 8" £4.95

Iris Scissors



6452 Straight 11.5cm 4.5" £3.00
6453 COF 11.5cm 4.5" £3.10

Kilner Scissors



6454 Fine 11.5cm 4.5" £4.95

Allis Tissue Forceps



6468 Allis 3 x 4 Teeth
15cm 6" £6.25

Crilewood Needle Holder



6472 Straight 15cm 6" £6.40

Iris Forceps



1178 Plain 11cm 4.5" £2.45
6463 1 x 2 Teeth
11cm 4.5" £3.50

Continental Forceps



6464 Plain 14cm 5.5" £2.80

Treves Forceps



6465 1 x 2 Teeth 13cm 5" £3.10

Volkman Spoon



- Double ended

6480 Small £9.50
6481 Medium £9.50
6482 Large £11.50

Endotracheal Forceps



6467 Endotracheal
Forceps £9.95

Rampléy Sponge Holder



6470 Rampléy 24cm 9.5" £8.80

Minor Surgery Instrument Set

- Comprising of
 - 1 x Scissors 5" straight blunt / blunt
 - 1 x Scissors Iris straight 4.5"
 - 1 x Scissors Littauer stitch cutting 5.5"
 - 1 x Needle Holder Mayo Hegar 6.5"
 - 1 x Spencer Wells artery forceps straight 6"
 - 1 x Dissecting forceps
 - 1 x Continental plain, 5.5"
 - 1 x Treves 1 x 2 teeth 6"
 - 1 x Splinter forceps Martins 5"
- Set supplied in imitation leather zipper case



6503 Minor Surgery Instrument Set £15.00

General Instrument Set

- Comprising of
 - 1 x McIndoe dissecting forceps 6"
 - 1 x Kilner needle holder
 - 1 x Iris scissors curved 4.5"
 - 1 x Vigo scissors 5"
 - 1 x Mayo-Hegar needle holder 6"
 - 1 x Spencer Wells artery forceps 5"
 - 1 x No.3 scalpel handle
- Set supplied in imitation leather zipper case



6505 General Instrument Set £15.00

minor surgery

Vernon Ball Head Percussor



- Nylon handle 25cm

6823 Vernon Ball Percussor £5.95

Queens / National Hospital Percussor



- Nylon handle 32.5cm

0809 Queens Percussor £5.95

Queens Telescopic Percussor



- 15 - 34cm

0806 Telescopic Percussor £19.00

Babinski Percussor



- Nylon handle 25cm

6824 Babinski Percussor £5.95

Taylor Percussor



- 20cm

0807 Taylor Percussor £9.95

Buck Telescopic Percussor



- With pin and brush

0808 Buck Telescopic Percussor £16.95

Stainless Steel Ware



6707	Gallipot 50ml	£4.30
6500	Gallipot 100ml	£5.75
6708	Kidney Dish 15cm	£5.00
6501	Kidney Dish 20cm	£6.95
6709	Instrument Tray 24H x 15W x 1.8D cm	£8.75
6502	Instrument Tray 30H x 20W x 3.5D cm	£14.75

Prep Razors



- Twin blades with protective cap
- Non sterile

3849 Prep Razors, pk/100 £15.85

Surgical Skin Marking Pen



- Distinct marking
- Easily removed
- Ruler printed on pen



SAVE MORE	1	10+
4717 Marking Pen	£1.10	£0.90

Disposable Holloware Products



- Made from environmental friendly paper pulp

3855	Kidney Dish, pk/300	1	£25.00
9602	General Purpose Bowl, pk/200	2	£24.00
9603	Multi Cup, pk/200	3	£15.50

Instrument Trays / Kidney Dish

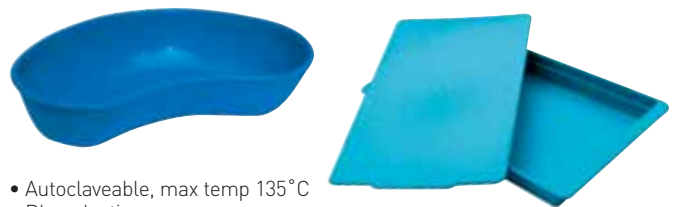

- Autoclaveable, max temp 135°C
- Blue plastic

1191	Tray Solid Plain Base, Size 19.5H x 13.5W x 2.3D cm	£2.60
1196	Lid for Tray Size 19.5H x 13.5W x 2.3D cm	£2.70
1192	Tray Solid Ribbed Base, Size 20H x 15W x 5.1D cm	£3.95
1197	Lid for Tray Sizes 20H x 15W x 5.1D cm	£3.00
1193	Tray Solid Ribbed Base, Size 27H x 15W x 3D cm	£3.70
1198	Lid for Tray Size 27H x 15W x 3D cm	£3.00
1194	Tray Mesh Base, Size 20H x 15W x 5.1D cm	£3.95
1195	Tray Mesh Base, Size 27H x 15W x 3D cm	£3.95
2522	Kidney Dish, graduated 300ml	£1.45
1199	Kidney Dish, graduated 1500ml	£3.25
2523	Gallipot, 35ml	£0.85

Velcro Tourniquet



- Universal size

6669 Velcro Tourniquet £2.30

Pull-tight Elasticated Tourniquet



- Finely woven green elasticated strap
- Quick pressure release control
- Very high quality at moderate cost

6810 Pull-tight Tourniquet £4.95

Prameta Grey Tourniquet



- Finely woven strap helps protect the patients skin
- Specially designed alloy buckle allows precise back pressure
- Easy to clean and fully autoclaveable

6811 Prameta Grey Tourniquet £25.75

Quick Release Tourniquets



- Available for Adults and Paediatric

9502	Adult Quick Release Tourniquet	£5.65
9503	Paediatric Quick Release Tourniquet	£6.45

Tytan Single Use Tourniquets



- Reduces the risk of cross-infection
- Size: 2.54 x 45 cm

9501 Single Use Tourniquets, pk/25 £6.99

Tourni-cot™



- Sterile single use
- Provides reliable and gentle pressure adequate to occlude the vessel
- Latex free
- Available in 4 colour coded sizes
- Easy to fit and easy to remove
- Available in Small, Medium, Large and Extra Large

9910 Sterile Tourni-cot £2.49

Gem II Ring Cutter



- Single hand touch button operation
- Cut any metal as hard as chrome plated steel up to 20 x 6mm deep
- 1 diamond and 2 silicone carbide cutting discs
- Batteries not supplied, requires 4 x AAA
- Rechargeable version supplied with charger and rechargeable batteries

7551	Gem II Ring Cutter	£104.50
7552	Gem II Rechargeable	£124.50
7555	Diamond Cutting Disc	£29.95
7556	Silicone Carbide Disc pk/6	£29.95
7558	Ring Spreader	£10.00
6805	Duracell AA Size, pk/4	£2.90

Ring Cutter



- Complete with blade

3644 Ring Cutter £21.00

Haemodril Nail Trephine



- Quick and efficient relief of pressure due to subungual haematomas
- Replaces the green needle and hot paper clip techniques
- Uses sterile pre-packed and specially designed spade trephines
- Supplied complete with 3 x sterile trephines and 2 x AA batteries in presentation case

7559	Trephine	£66.00
7563	Trephines Sterile pk/10	£39.00

BD Vacutainer Needles



- Blood collecting needles specific to the Vacutainer system



7464	Needle 20G x 11/2", pk/100	£15.55
7465	Needle 21G x 1", pk/100	£15.55
7466	Needle 21G x 11/2", pk/100	£15.55
7467	Needle 22G x 1", pk/100	£15.55

BD Microlance™ Needles



- Regular bevel
- Sterile



9725	18G x 1 1/2" Pink, pk/100	£5.50
9726	19G x 1 1/2" Cream, pk/100	£5.50
7459	21G x 1 1/2" Green, pk/100	£5.50
9727	21G x 2" Green, pk/100	£5.50
7460	23G x 1" Blue, pk/100	£5.50
7461	23G x 1 1/4" Blue, pk/100	£5.50
7462	25G x 5/8" Orange, pk/100	£5.50
7463	25G x 1" Orange, pk/100	£5.50
9728	26G x 1/2" Brown, pk/100	£5.50
9729	30G x 1/2" Yellow, pk/100	£5.50

BD Venflon Infusion Cannula



7470	14G Orange	£1.35
7471	16G Grey	£1.35
7472	18G Green	£1.35
7473	20G Pink	£1.35
7474	22G Blue	£1.35
7475	Neoflon 24G Yellow	£2.50

BD Plastipak Luer Slip Syringes



7454	1ml, pk/100	£6.95
7455	2ml, pk/100	£3.95
7456	5ml, pk/100	£5.25
7457	10ml, pk/100	£7.75
7458	20ml, pk/120	£19.50
9724	60ml, pk/60	£28.75

BD Plastipak Luer Lock Syringes



9718	1ml, pk/100	£32.75
9719	3ml, pk/100	£12.00
9720	5ml, pk/100	£12.50
9721	10ml, pk/100	£16.50
9722	20ml, pk/120	£29.75
9723	60ml, pk/60	£29.75

BD Micro-Fine Insulin Syringes



9715	0.3ml 30G 8mm, pk/100	£15.80
9716	0.5ml 30G 8mm, pk/100	£15.80
9717	1ml 29G 12.7mm, pk/100	£15.80

Baxter Infusion Solutions and Water for Injection



9800	Glucose 5%, 500ml	£1.80
9803	Sod. Chloride 0.9%, 100ml	£1.50
9804	Sod. Chloride 0.9%, 500ml	£1.95
9805	Sod. Chloride 0.9%, 1000ml	£2.50
9806	Hartmann's Solution – Compound Sodium Lactate, 500ml	£1.85
9807	Hartmann's Solution – Compound Sodium Lactate, 1000ml	£3.75
9801	Water for Injection, 100ml	£2.65
9802	Water for Injection, 1000ml	£4.95

BD Plastipak Luer Slip Syringes



7454	1ml, pk/100	£6.95
7455	2ml, pk/100	£3.95
7456	5ml, pk/100	£5.25
7457	10ml, pk/100	£7.75
7458	20ml, pk/120	£19.50
9724	60ml, pk/60	£28.75

Portex IV Solution Giving Set



- 'Y' type injection

5691	Giving Set	£1.40
------	------------	-------

Surgical Scalpel Blades



- Carbon steel sterile blades
- Individual foil packed
- Blade numbers 10 – 15 to be used with handles B3, 3, 3 graduated, 7, 9
- Blade numbers 20 – 24 to be used with handles 4, 4L, 6B

1201	No.10, pk/100	£7.95
2475	No.11, pk/100	£7.95
1202	No.15, pk/100	£7.95
8388	No.20, pk/100	£8.95
8389	No.21, pk/100	£8.95
8390	No.22, pk/100	£8.95
8391	No.23, pk/100	£8.95
8392	No.24, pk/100	£8.95
7590	Stitch Cutter, pk/100	£9.95

Surgical Scalpel Handles



No.4 G No.3 G No.7 No.9 No.B3

- Stainless steel, non-sterile handles

8298	Handle No.4 Graduated, for blades 20 - 24	£2.90
1216	Handle No.3 Graduated, for blades 10 - 15	£2.90
1217	Handle No.7, for blades 10 - 15	£2.90
1218	Handle No.9, for blades 10 - 15	£2.90
2518	Handle No. B3, for blades 10 - 15	£11.50

Disposable Sterile Scalpels

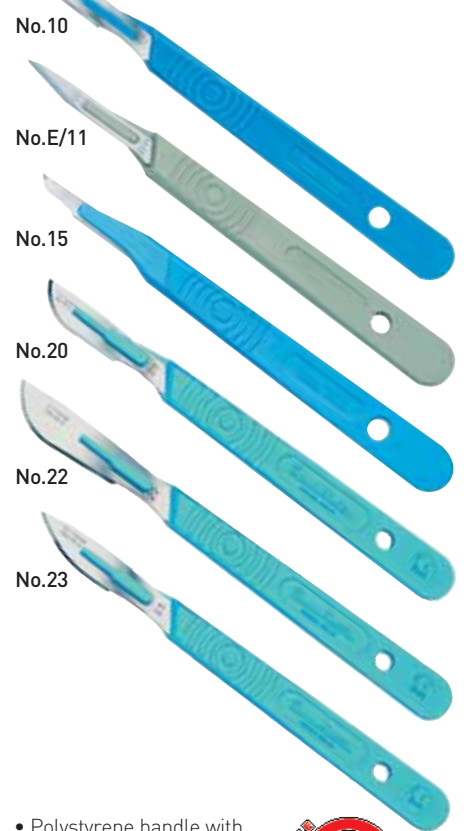

- Polystyrene handle with stainless steel blades
- Sterile, individually wrapped



1211	Scalpel No.10, pk/10	£2.75
1213	Scalpel No.E/11, pk/10	£2.90
1212	Scalpel No.15, pk/10	£2.75
8395	Scalpel No.20, pk/10	£2.90
8396	Scalpel No.22, pk/10	£2.90
8397	Scalpel No.23, pk/10	£2.90

Retractable Disposable Scalpels



- Disposable sterile retractable scalpel blades



8426	Retractable No.10, pk/25	£21.00
8427	Retractable No.11, pk/25	£21.00
8428	Retractable No.15, pk/25	£21.00

U Blade for Skin Scraping



- Banana shaped blade for skin samples
- Blades are sterile, disposable and individually wrapped
- Stainless steel
- Requires Swann Morton Major Handle



8394	U Blades, pk/50	£11.30
8393	Major Handle for U Blades	£3.40

Clicksmart Blade Remover



- Single handed scalpel blade remover
- Holds 100 blades
- Built-in counter & automatic shut off when full
- Fits all common blades and handles
- Easy mounting on a counter, or the wall for one-handed blade removal to reduce the risk of injury
- Fully compliant with the recently revised OSHA Regulations (Standards-29 CFR) Blood borne Pathogens

8295	Blade Remover	£14.30
------	---------------	--------



Ethilon Sutures



- Monofilament Polyamide Non Absorbable Suture
- Smooth to give easy passage through patient skin
- Synthetic for minimal tissue reaction



Code	Man Code	Needle	Length	Colour	Gauge	Description	Qty	D/T	Price
9730	W1614T	16mm	45cm	Black	6-0 0.7	3/8 circle Reverse Cutting PRIME Needle	24		£59.50
7446	W1615T	16mm	45cm	Black	6-0 0.7	3/8 circle Conventional Cutting PRIME Needle	24	Yes	£55.15
9731	W1616T	16mm	45cm	Blue	5-0 1	1/2 circle TAPERCUT Needle	24		£56.50
9732	W1618T	19mm	45cm	Black	5-0 1	3/8 circle Reverse Cutting PRIME Needle	24	Yes	£56.50
9733	W1620T	19mm	45cm	Blue	4-0 1.5	3/8 circle Reverse Cutting PRIME Needle	24		£56.50
9734	W1625T	26mm	45cm	Blue	3-0 2	3/8 circle Conventional Cutting PRIME Needle	24		£56.50
7447	W319	19mm	45cm	Blue	4-0 1.5	3/8 circle Reverse Cutting Needle	12	Yes	£18.50
7448	W320	26mm	45cm	Blue	3-0 2	3/8 circle Reverse Cutting Needle	12	Yes	£18.50
7449	W736	45cm	100cm	Black	2-0 2	3/8 circle Reverse Cutting Needle	12		£21.90

Coated Vicryl Rapide Sutures

- Braided – for easy handling and secure knot tying
- Coated – for smooth passage through tissue and easy knot tie down
- Synthetic – for minimal tissue reaction
- Absorbable – rapid absorption complete by 42 days
- Tensile strength – Approximately 50% of original strength remaining after 5 days
- All of the original tensile strength is lost by 10 -14 days post implantation
- Normally, the removal of the suture is not required



Code	Man Code	Needle	Length	Colour	Gauge	Description	Qty	D/T	Price
9746	W9918	16mm	75cm	Undyed	4-0 1.5	3/8 circle Conventional Cutting PRIME Needle	12	Yes	£52.65
9747	W9922	19mm	75cm	Undyed	4-0 1.5	3/8 circle Conventional Cutting PRIME Needle	12	Yes	£59.00
9748	W9923	19mm	75cm	Undyed	3-0 2	3/8 circle Reverse Cutting PRIME Needle	12	Yes	£54.95
9749	W9932	26mm	75cm	Undyed	3-0 2	3/8 circle Conventional Cutting PRIME Needle	12	Yes	£55.30

Coated Vicryl Sutures

- Braided – for easy handling and secure knot tying
- Coated – for smooth passage through tissue and easy knot tie down
- Synthetic – for minimal tissue reaction
- Absorbable – 28 days wound support time, absorption is essentially complete between 56 and 70 days



Code	Man Code	Needle	Length	Colour	Gauge	Description	Qty	D/T	Price
9739	W9114	20mm	75cm	Violet	3-0 2	1/2 circle TAPER Point Plus Needle	12		£44.95
9740	W9390	36mm	75cm	Violet	2-0	3/8 Reverse Cutting Needle	12		£54.95
9741	W9418	60mm	75cm	Violet	2-0	Straight Conventional Cutting Needle	12		£44.95
9742	W9443	16mm	75cm	Violet	4-0	3/8 Circle Conventional Cutting Needle	12		£54.95
9743	W9471	22mm	45cm	Violet	4-0	1/2 Circle Conventional Cutting Needle	12		£54.95
9744	W9521	26mm	45cm	Undyed	3-0 2	3/8 Circle Conventional Cutting Prime Needle	24		£97.70
9745	W9741	22mm	45cm	Undyed	3-0	1/2 Circle Conventional Cutting Needle	12		£44.95

Monocryl Sutures

- Poliglecaprone 25 monofilament suture – for smooth passage through tissue
- Synthetic – for minimal tissue reaction
- Absorbable – wound support time of 2 weeks, absorption is complete between 90 and 120 days



Code	Man Code	Needle	Length	Colour	Gauge	Description	Qty	D/T	Price
9735	W3204	16mm	45cm	Undyed	5-0	13/8 circle Reverse Cutting PRIME Needle	12		£53.00
9736	W3205	16mm	45cm	Undyed	4-0 1.5	3/8 circle Reverse Cutting PRIME Needle	12		£53.00
9737	W3206	19mm	45cm	Undyed	4-0 1.5	3/8 circle Reverse Cutting PRIME Needle	12		£53.00
9738	W3207	19mm	45cm	Undyed	3-0 2	3/8 circle Reverse Cutting PRIME Needle	12		£53.00

Mersilk Sutures

- Braided – for easy handling and secure knot tying
- Coated with wax – does not become limp or brittle
- Biological – produced from cocoons of the silk worm Bombyx Mori - this material may elicit a foreign body reaction
- Non-absorbable



Code	Man Code	Needle	Length	Colour	Gauge	Description	Qty	D/T	Price
9754	W328H	26mm	45cm	Black	3-0 2	3/8 Circle Reverse Cutting Needle	36		£79.75
9755	W500H	16mm	75cm	Black	5-0 1	3/8 Circle Conventional Cutting Needle	36		£89.75
9753	W502H	16mm	75cm	Black	3-0 2	3/8 Circle Conventional Cutting Needle	36		£76.75

Prolene Sutures

- Non-absorbable – provides permanent tensile strength retention in tissue
- Smooth surface for easy passage through tissue
- Sterilisation – Ethylene oxide



Code	Man Code	Needle	Length	Colour	Gauge	Description	Qty	D/T	Price
9751	W8005T	16mm	45cm	Blue	6-0 0.7	3/8 Circle Conventional Cutting PRIME Needle	24		£79.90
9752	W8006T	16mm	45cm	Blue	5-0 1	3/8 Circle Conventional Cutting PRIME Needle	24		£79.90
9750	W8020T	26mm	45cm	Blue	4-0 1.5	3/8 Circle Conventional Cutting Needle	24	Yes	£65.05

Stitch Cutter Blade



- Traditional carbon steel sterile standard stitch cutter
- Rounded bull nose tip ensures there is no damage to the skin whilst the surgical edge cuts through the suture



7590	Stitch Cutter Blade, pk/100	£9.95
------	-----------------------------	-------

3M Steri-Strip



- Reinforced Steri-Strip skin closures provide general wound support for increased tensile strength and finer wound edge approximation
- 3 Strips in each pack

9793	3 x 75mm, pk/12	£12.75
9794	6 x 75mm, pk/12	£12.75
9795	12 x 100mm, pk/12	£16.35

EpiGlu Skin Adhesive

- Pain free
- Single patient use
- Holds wound edges even under tension e.g. around joint areas
- The first layer polymerises within seconds then multiple layers close and protect the wound from infection
- Easy to apply
- Results in almost no keloid scarring
- Patients can resume daily personal hygiene - washing, showering
- No anaesthetic required



4719	EpiGlu Skin Adhesive, pk/10	£56.40
------	-----------------------------	--------

Emla Cream



- Local anaesthetics, works by numbing the surface of the skin for a short time, helping to stop pain felt on the skin
- Contains two medicines called Lidocaine and Prilocaine
- Suitable for: Injections, blood tests, minor skin operations, tattoos and some types of skin graft

9796	Emla Cream 5gm	P £2.70
9797	Emla Cream 30gm	P £15.90

Elemental Cautery Handi Set



501 Straight Cutter
502 Angled
503 Loop Cutter
504 Needle Cold Point
505 Co-agulation Ball

- Robust chrome-brass handle, with exact contact control and Teflon connector
- Tips manufactured from platinum-iridium, long lasting, non oxidising
- Fully autoclaveable handle and tips – excluding batteries
- 501, 504, 505 burners available as single use - please specify number when ordering
- 501, 502, 503, 504, 505 burners available as reusable - please specify number when ordering
- Supplied with 5 tips; Coagulation ball, Straight tip, Angled tip, Loop and Cold point in case with 2 x AA batteries



6919	Handi Set with 5 x Reusable Tips	£245.00
6922	Reusable Tips - specify number	£27.50
6916	Single Use Tips - specify number	£19.50

Battery Operated Cautery Set

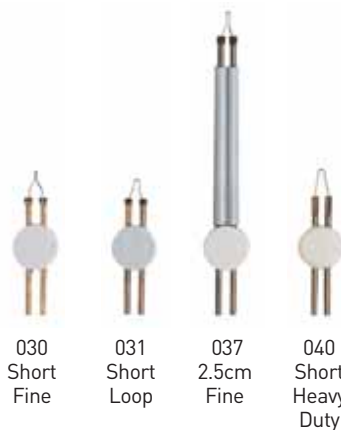

030 Short Fine
031 Short Loop
037 2.5cm Fine
040 Short Heavy Duty

- Economical battery powered cautery
- Suitable for basic application minor surgery
- Simple push connection tips
- Fingertip power control
- Includes range of disposable single use tips available
- Supplied with 2 x large, 2 x small disposable tips and 2 x AA batteries in case



6927	Cautery Set with 4 x Single Use Tips	£45.00
6928	Single Use Tips - specify number	£8.00

Disposable Single Patient Use Cauteries



Disposable Single Patient Use Cauteries overcomes the problem of cleansing and sterilisation of conventional tips.

- Simple and convenient to use
- Cauterise are supplied sterile
- Choice of tip configuration to cater for most demands



6798	Single Use Cautery 1204°C Fine Tip	£13.50
6799	Single Use Cautery 1204°C Loop Tip	£13.50
6800	Single Use Cautery 982°C Vasectomy Tip	£13.50
6801	Single Use Cautery 1093°C Micro Tip	£13.50
6802	Single Use Cautery 1093°C Microloop Tip	£13.50
6803	Single Use Cautery 871°C Micro Vasectomy Tip	£13.50

Elemental Mains Cautery



- High quality mains cautery unit
- Variable output control up to 20 ampere
- Non-slip adjustable feet
- Robust cables and handle
- Choice of either Standard handle or Pistol Grip control handle
- 201, 204 tips available as single use tips - please specify number when ordering
- 201, 204, 205, 207, 215 available as reusable tips - please specify number when ordering
- Tips manufactured from platinum-iridium, non oxidising, non corroding
- Supplied with 5cm reusable tips; Coagulation ball, Ring cutter tip, Straight tip, Loop and Cold point

6893	Cautery Mains Unit with 5 Tips, Pistol Grip Handle	£789.00
6894	Cautery Mains Unit with 5 Tips, Standard Grip Handle	£789.00
6895	Reusable Tips - specify number	£47.50
6910	Single Use Tips - specify number	£19.50



Elemental Rechargeable Cautery Set

- Elemental Cautery system with rechargeable power supply
- Exceptionally compact 'foot-print' on desk charger, ideal for surfaces where space is at a premium
- Hygienic design - no awkward or difficult to clean areas
- Simple to use - just plug-in, recharge and use
- Intelligent charging system with NiMH rechargeable battery
- Fully charged from empty in 3 hours
- 10 to 15 minutes continual operation from a full charge
- Twin lamp charging indicators
- Slim handle with exact-touch control, highly accurate and well balanced in use
- Fully autoclaveable handle and tips (excluding battery)
- 504, 510 available as single use burners, please specify number when ordering

3 Burner Set comprises:

- Ring Cutter
- Straight Cutter
- Coagulation Ball

5 Burner Set comprises:

- Ring Cutter
- Straight Cutter
- Coagulation Ball
- Needle/Cold Point
- Angled Tip

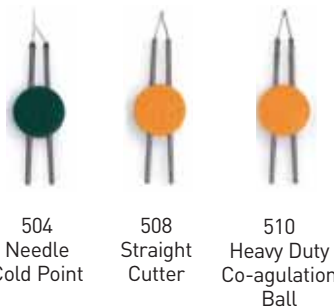

6913	Rechargeable Cautery without Burners	£509.00
6914	3-Burner Set	£87.00
6915	5-Burner Set	£138.00
6916	Single Use Burners - specify number	£19.50



Coa-Comp M Automatic Bipolar Electro Coagulator

NEW



- Lightweight, cost-effective and ideal for any surgical environment demanding fast and precise bipolar coagulation
- The intelligent coagulation system gives an improved aesthetic result for the patient and extends the life of the equipment
- Small, light and quick to deploy, perfect for rapid reaction bleeding
- Computer controlled coagulation prevents charring of tissue
- Stops coagulation before the tissue is over-coagulated, therefore enhancing the non-stick characteristics of bipolar instruments
- With a pair of bipolar scissors connected to the Coa-Comp M the automatic operation can be used for haemostasis right between the cutting edges
- Bipolar forceps needs to be ordered separately

9822	Coa-Comp M Electro Coagulator	£2500.00
4724	Single Use Bipolar Forceps with Cable, pk/20	£379.00
9823	Reusable 4.5" Bipolar Forceps with Cable	£178.00

Acu-Evac IE II Surgical Smoke Evacuator



Hyfreacator not included



Invest in the safety of your staff and patients

Advanced, patented, high efficiency filtration system for eliminating surgical smoke plume which may contain hazardous bio-aerosols, live and dead cellular matter (including blood fragments & viruses). Surgical smoke plume can also be carcinogenic, which is another key reason to invest in the Acu-Evac to protect patients and staff.

- Can be used with both Hyfreacator 2000 and Schuco 120 Electrosurgical Unit - a mounting bracket is required for the Schuco 120
- Eliminates unpleasant odours associated with electro surgery or cautery
- Powerful, portable, easily stored
- Boom arm allows single operator use, with both hands free to perform skin surgery
- System comprises of one of each:- Acu-Evac IE II machine, Main Filter, TX Nozzle, all tubing, footswitch, mobile stand & boom arm

4729	Acu-Evac IE II Surgical Smoke Evacuator	£1995.00
7537	Acu-Evac IE IMounting Bracket for Schuco 120	£170.00

Hyfrecator 2000 Electrosurgery Unit

- Ideal for the treatment of Benign Moles, Common viral warts, Seborrheic warts, Skin tags, Solar keratoses, Spider naevi, Telangiectasias, Venereal warts, etc
- Complete all-in-one ready-to-use diathermy machine
- Remote power control, saving procedure time
- Allows 3 separate power settings to be stored - low power, hi power and bipolar
- Precise rapid destruction of all types of cutaneous lesion - both superficial and deep
- Controls surgical bleeding simply, quickly and effectively
- Delivers rapid, precise destruction of all types of cutaneous malformation, including telangiectasia and unwanted hair growth
- Provides controlled tissue coagulation and precise surgical haemostasis using bipolar coagulation
- Small lesions can be treated without anaesthesia
- Fingertip control for increasing and decreasing power
- Digital power display
- Pack includes: reusable hand switching pencil, starter box of non-sterile electrolase tips blunt & sharp, patient plate, wall mount kit, operators manual and training CD

Hyfrecator 2000FS

- Specification as above but with footswitch making this model ideal for delicate procedures. The operator can control power on/off from the foot pedal rather than the handpiece

Hyfrecator 2000FSB

- Specification as above but with footswitch and bipolar forceps for coagulation and haemostasis



Now includes Patient Plate

2704	Hyfrecator 2000 with Switching Handle	1	£1070.00
4721	Hyfrecator 2000FS with Foot Switch		£1268.00
4722	Hyfrecator 2000FSB with Bipolar Forceps & Footswitch		£1446.00

Hyfrecator Accessories

2705	Hyfrecator Footswitch Conversion Kit for code 2704		£198.00
2706	Hyfrecator Bipolar Conversion Kit for codes 2704 & 4721		£376.00
2707	Hyfrecator Mobile Pedestal Stand	2	£249.00

Single Use Hyfrecator Consumables

4724	Single Use Bipolar Forceps with Cable, pk/20	£379.00
4725	Single Use Electrolase Tips Non Sterile Sharp, pk/100	£59.00
4726	Single Use Electrolase Tips Non Sterile Blunt, pk/100	£59.00
2708	Single Use Electrolase Tips Sterile Sharp, pk/50	£59.00
2709	Single Use Electrolase Tips Sterile Blunt, pk/50	£59.00
4727	Disposable Handle Sheaths Non Sterile, pk/100	£19.00
2710	Disposable Handle Sheaths Sterile, pk/25	£75.00
4728	Single Use Vasectomy Needle Electrode, pk/40	£109.00



Schuco 120 Electrosurgical Unit

Schuco 120 is an electrosurgical unit for minimally invasive surgical procedures – ideal for the treatment of a variety of skin conditions. This unit will give you the flexibility of cut, coagulation as well as a combined cut and coagulation setting.

- Pure cut, CUT
- Coagulated cut, BLEND
- Superficial coagulation, COAG FORCED
- Deep coagulation - without carbonisation, COAG SOFT
- Bipolar coagulation, BIPOLAR with adaptor

Supplied complete with the following re-usable accessories:

- Cable for neutral plate disposable/5365
- Assorted electrodes 5cm, pack of 10
- User manual
- Footswitch
- Power lead 2 metre
- Re-usable handle with finger switches
- Steel neutral electrode size 12 x 16 cm



4720	Schuco 120 Electrosurgical Unit	£1645.00
------	---------------------------------	----------



Histofreezer®



- A professional-grade product that offers medical professionals an easy and effective method to treat nine different types of skin lesions, including common plantar and genital warts and other common benign skin lesions
- Ultra-portable, one-handed operation
- Treatment takes less than 60 seconds
- Clinically-proven results, safe and easy to use
- Results are comparable to liquid nitrogen with a lower risk of scarring
- CFC-free and ozone-friendly

9462-2	Histofreezer with 60 x 2mm Applicators	£74.00
9462-5	Histofreezer with 50 x 5mm Applicators	£72.00

Dermafreeze™



- Controlled delivery of an aerosol based cryogen, freezes down to -50°C
- Cryofunnel™ allows liquid nitrogen to be delivered precisely to verrucas, warts, skin tags, papillomas and other benign superficial skin growths
- Cryofunnel™ triangles provides circular openings of 5mm, 10mm and 15mm
- For smaller areas foam tipped applicators of 2mm and 5mm can be used
- Up to 80 individual treatments from each can
- Dermafreeze™ 200ml supplied with 30 x Cryofunnel™ triangles, 40 x Cryotips™ - 20 each 2mm and 5mm

7564	Dermafreeze	£54.95
3099	Dermafreeze 200ml Refill Can	1 £29.95
3100	Dermafreeze Cryofunnel™, pk/30	2 £9.95
3101-2	Dermafreeze Cryotips™ 2mm, pk/20	3 £9.95
3101-5	Dermafreeze Cryotips™ 5mm, pk/20	£9.95

Cryospray 59



- Dispensing head designed for greater control
- Delivers up to 60 applications
- Designed to freeze tissue to temperatures of around -59°C
- Includes 12 cotton wool tipped applicators for the treatment of small verrucas
- 300ml

0460	Cryospray 59	£34.25
------	--------------	--------

Cryoalfa Super Portable Cryosurgery Pencil



- The freezing of tissue requires a high freezing speed, at the rate of minimum of 100 K / min
- Cryosurgical devices are provided with a specific liquid gas dosing feeder
- Operator is able to bring out precisely the liquid N_2O gas onto the lesion without gas loss
- With a temperature of -89°C / -128°F the liquid gas evaporates on the lesion
- Removes heat from the surrounding tissue and effects a freezing of the treated area
- Low temperature is converted to therapeutic energy nearly without loss
- Tissue cells are destroyed irrevocably
- Dimensions: L125 mm; \varnothing 23 mm
- Weight: Fully filled with gas = ~ 60g
Empty cartridge = ~ 45g

Cartridge

- Content: Nitrous oxide gas (N_2O)
- Melting point: -128°F (-89°C)
- Net weight: 15.0 +/- 0.4g

9699	Cryoalfa Super	£199.00
9700	Cartridge 16g	£25.00

Liquid Nitrogen Spray Jet Dispenser



FREE
CARRY CASE
INCLUDED
Worth £45.00



- Used to treat a wide range of benign and malignant skin lesions
- Delivers a precise fine spray of liquid nitrogen to the site of the lesion in a reproducible manner
- Flask available in two sizes; 330ml or 450ml
- Supplied with four spray tips and lance
- Complete in lockable robust carrying case
- Additional probes and safety shield & gloves available
- Service and repair facility



With Ongoing Service & Repair Facility

7000	CP33 330ml capacity with Carry Case	1	£435.00
7001	CP45 450ml capacity with Carry Case		£455.00
7004-1	Slim Probe 1mm	2	£49.00
7004-2	Slim Probe 2mm		£49.00
7004-3	Slim Probe 3mm		£49.00
7002	Cryo Safety Face Shield	3	£42.85
7003	Cryo Gloves, pair	4	£32.85

Training in the Safe Use of Liquid Nitrogen & Equipment

We are pleased to offer on-site training lasting between 2 to 3 hours providing both instruction and practical tuition using your equipment.

The training will be for up to 4 key personnel. Training will take place once the equipment has been delivered.



7145	Cryogenic Training	£285.00
------	--------------------	---------

Training offshore and Scottish Highlands will be by quotation

If you need Cryolab Liquid Nitrogen Storage Dewars please contact us

CryoSuccess Portable Cryosurgery Pencil



- A simple and effective handheld Cryotherapy device for accurate treatment of skin lesions making it ideal for minor surgery applications
- **Cartridge provides 30-40 treatments**
- Freezes to -89°C and to a depth of 3mm
- Cartridge can be removed at any time - for longer term storage or transport - and then rapidly reconnected
- Comprises: 1 x CryoSuccess (with standard 1mm application tip & protective cap), 1 x cartridge, 1 x pin, 1 x instructions for use, all contained in an ABS protective case

2702	CryoSuccess	£595.00
------	-------------	---------

Replacement CryoSuccess Cartridge

- Cartridge provides 30-40 treatments
- Cartridge can be safely removed from the head in between clinics, which prevents leakage

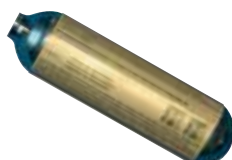

For CryoAlfa cartridges please enquire

2703	CryoSuccess Cartridges, 23.5g inbuilt filter	£31.40
------	--	--------

